

N E X O R

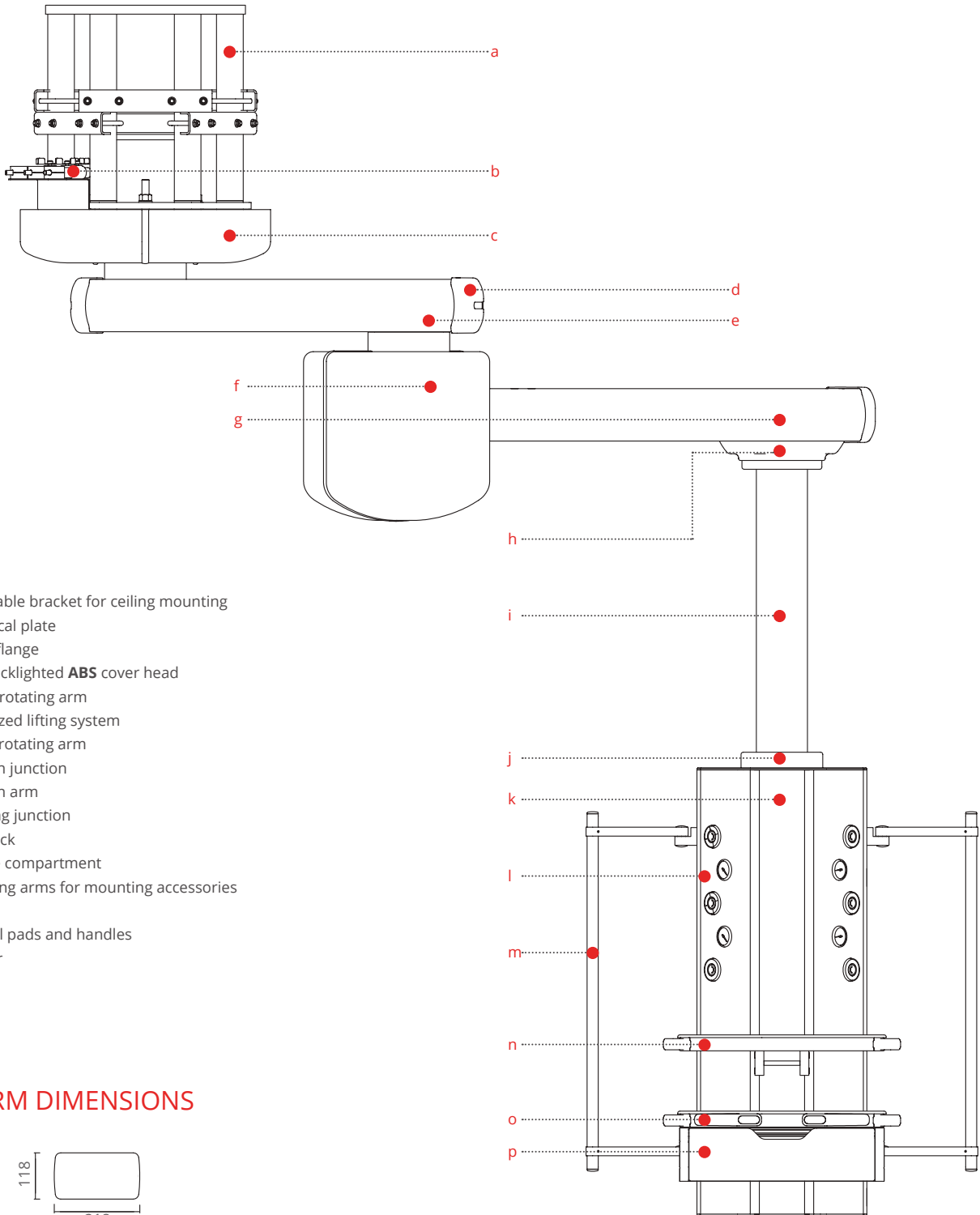

PROFILE OVERVIEW



- a - Adjustable bracket for ceiling mounting
- b - Technical plate
- c - Cover flange
- d - LED backlighted ABS cover head
- e - Upper rotating arm
- f - Motorized lifting system
- g - Lower rotating arm
- h - Column junction
- i - Column arm
- j - Rotating junction
- k - Rail track
- l - Service compartment
- m - Swiveling arms for mounting accessories
- n - Shelf
- o - Control pads and handles
- p - Drawer

ARM DIMENSIONS



HEAD DIMENSIONS

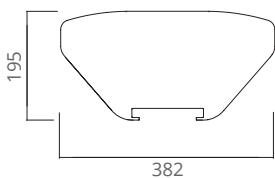

This image is for general demonstration only.

The number of services varies according to the specifications given by each customer.

LOADING CAPACITIES

SINGLE ARM

Lenght	Load capacity
600 mm	400 kg
900 mm	270 kg
1200 mm	200 kg

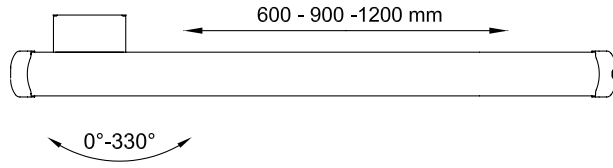

DOUBLE ARM

Lenght	Load capacity
(600+600) 1200 mm	220 kg
(900+600) 1500 mm	200 kg
(900+900) 1800 mm	180 kg
(1200+900) 2100 mm	150 kg

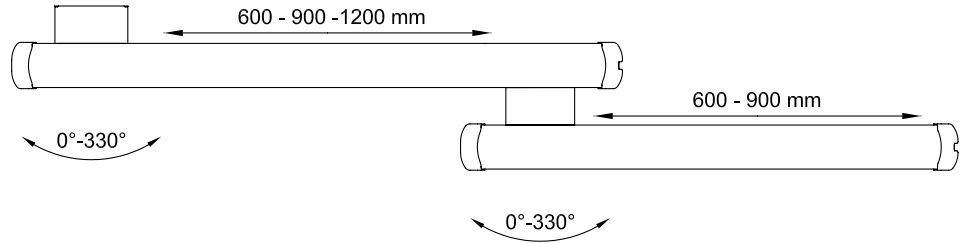

SINGLE MOTORIZED ARM

Lenght	Load capacity	Travel
700 mm	260 kg	420 mm
1000 mm	180 kg	600 mm
1250 mm	145 kg	750 mm

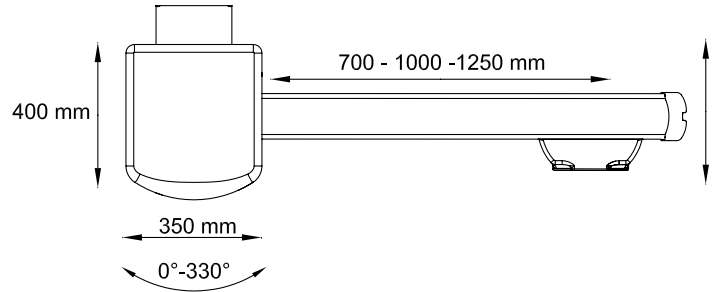

travel time: 27 seconds

DOUBLE MOTORIZED ARM

Lenght	Load capacity	Travel
(600+700) 1300 mm	260 kg	420 mm
(600+1000) 1600 mm	180 kg	600 mm
(900+700) 1600 mm	260 kg	420 mm
(900+1000) 1900 mm	180 kg	600 mm

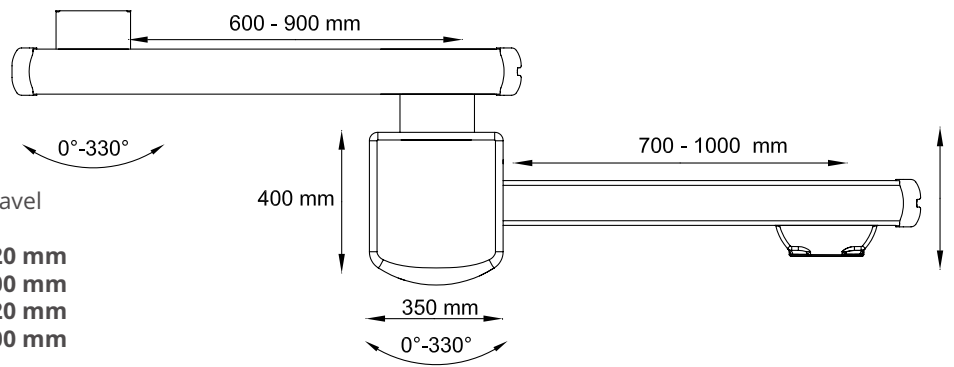

travel time: 27 seconds

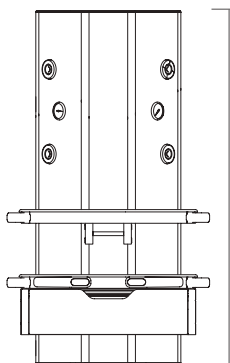

Head column hight	Maximum number of electrical devices	Maximum number of gas outlet	Total Maximum number of devices
600 mm	12 pcs	8 pcs	29 pcs
1000 mm	22 pcs	14 pcs	32 pcs
1200 mm	28 pcs	16 pcs	35 pcs
1500 mm	36 pcs	20 pcs	43 pcs
1700 mm	40 pcs	22 pcs	46 pcs

SINGLE AND DOUBLE ARM | FRONT VIEW

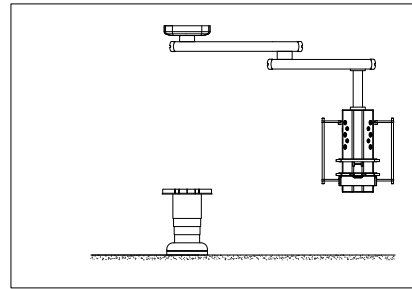
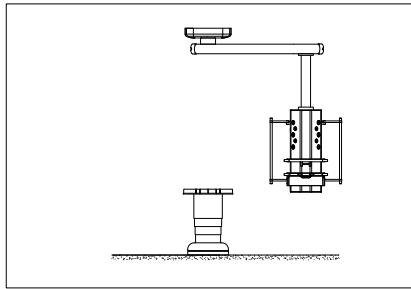

SINGLE AND DOUBLE MOTORIZED ARM | FRONT VIEW

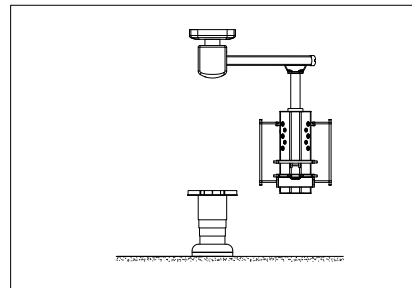
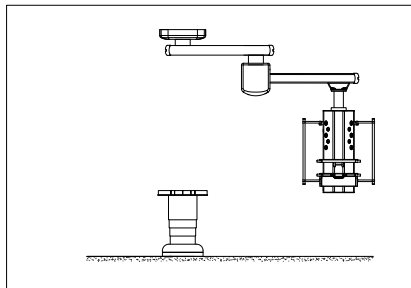

TANDEM ARMS | FRONT VIEW

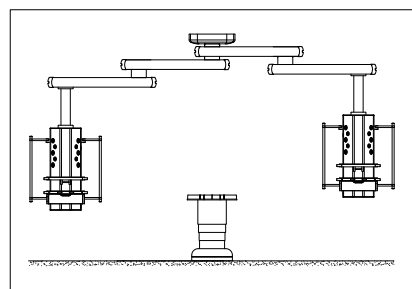
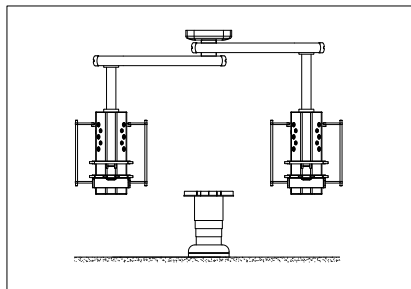

TANDEM MOTORIZED ARMS | FRONT VIEW

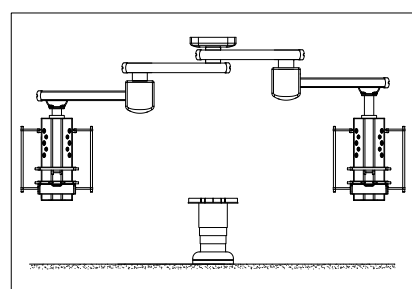
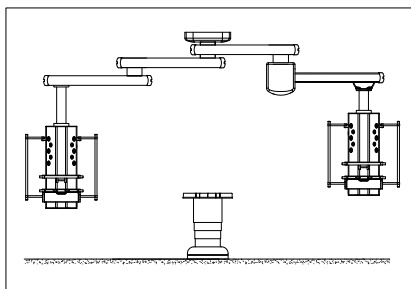

TECHNICAL DATA SHEET

Testing in production for each single unit	For each unit the following tests are performed: -grounding impedance protection in accordance with 18f) of standard 60601-1 - standard measurement of leakage current in accordance with 19.3 and 19.4 of EN 60601-1-measurement of dielectric strength, in accordance with 20.3 and 20.4 of standard EN 60601-1 – requirements as in 59.101.1, 59.102.1 and 59.103.1; 59.101.2); 59.102.2 b), 59.103.2); 59.101.2 BC), 59.102.2 (c) and 59.103.2. b) – pressure tests in accordance with 59.101.2. d) and 59.102.2. d) Tests carried out on end-of-line product form an integral part of this manual.
EC CERTIFICATE 1548/MDD	The devices are made in compliance with Directive 93/42/EEC concerning medical devices Annex II with certification CE0051.
Regulation	The equipment should be considered class IIb .
Classification according to the type of protection against electrical hazards	Class I device. The protection against electric shock is guaranteed by the metal parts of the ground protection.
Classification according to the degree of protection against penetration of liquids and external agents	IP20.
Classification according to the use and conditions	Device for continuous operation.
Electromagnetic interference	The operation of other devices placed near the medical device (as portable equipment or furniture) can cause electromagnetic interference or other interference, always check with qualified personnel.
Protection provided on external power circuit	Provides adequate protection with circuit breakers or fuses dimensioned according to the power indicated on the label.
Supply voltage	220/230 V-AC 50/60 Hz different supply voltage available upon request.
Low voltage	12/24V-AC/DC.
Wire minimum section	Lights 1.5 sq.mm. Electrical sockets 2.5/4 sq.mm. Ground 2.5/6 sq.mm.
Conditions for Storage	Temperature: between -10°C and +40°C. Relative humidity: between 30% and 75%.
Conditions for Usage	Temperature: between +5°C and 35°C. Relative humidity: between 30% and 75%.
Maintenance	The pendant does not require routine standard maintenance but only long term one. Medical gases and electrical components are kept separated : for this reason no special caution during maintenance service is needed.
Cleaning	The epoxy-polyester paint or the anodic oxidation guarantee the durability of all external surfaces. Cleaning is recommended with soft cloth soaked with non-alcoholic and gentle detergents and disinfectants.
Testing	The products are fully tested and ready for immediate installing.
Ceiling fixing	Clamped onto the ceiling with an adjustable support.
Aluminium	Structural profile not less than 3.5mm/cover profile not less than 1.8mm Alloy 6063 T6.
Pneumatic Brakes	6 BAR maximum pressure.
Gas connection	Through NIST or VALVE with flexible antistatic hoses.
Quality management systems	ISO 9001:2008 EN ISO 13485:2012

Nexor Medical GmbH
Stockacher Str. 134
78532 Tuttlingen
Germany

Fon +49 7461 96577480
Fax +49 7461 96577489

info@nexormedical.com
www.nexormedical.com